

# DLP columns and mini-column

## 4 compartments

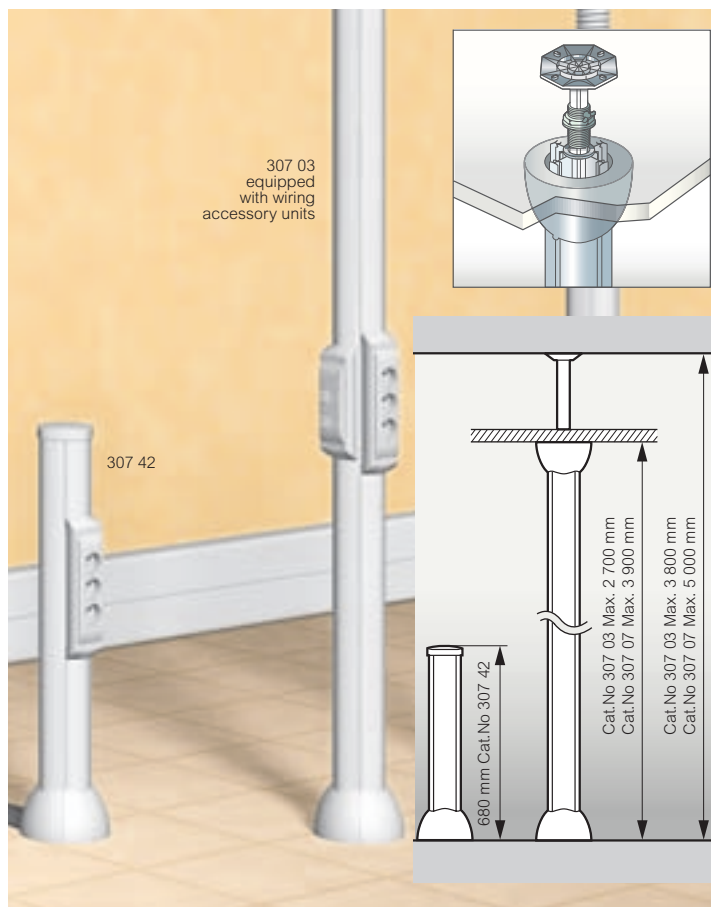
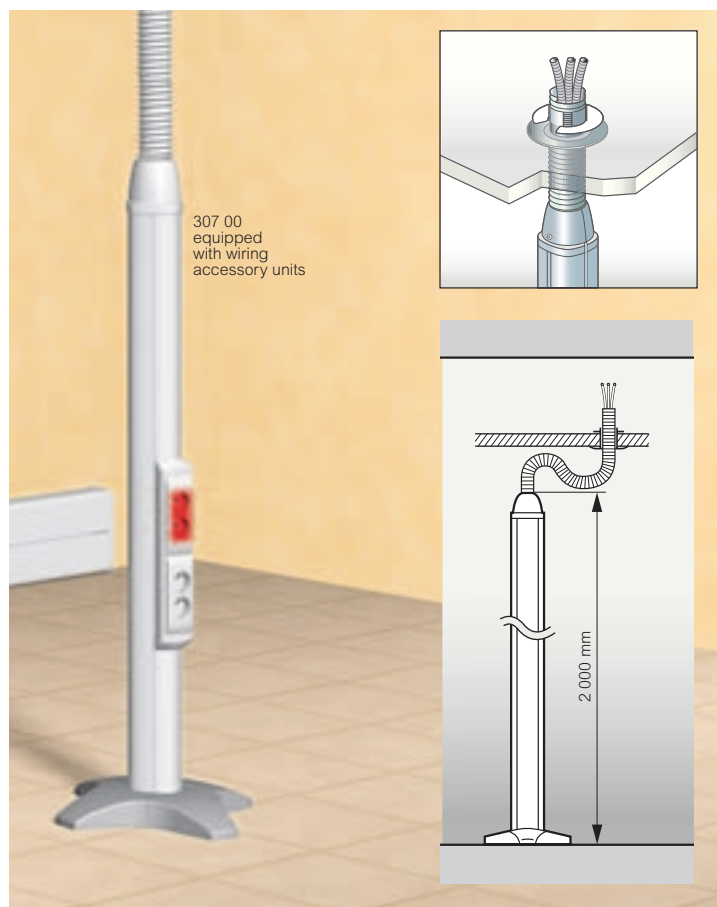

- For vertical distribution of currents with the cable inlets of high and low current cables in separate conduits
- Power supply from the ceiling and/or the floor
- To be equipped with wiring accessory units

Pack	Cat.Nos	Movable column to be equipped
1	307 00	<p>Comprising :</p> <ul style="list-style-type: none"> <li>• An aluminium base, length 2 m, 4 compartments</li> <li>• A Ø60 mm flexible sheath, capacity 4 x Ø20, length 2 m</li> <li>• 1 foot, 12 kg, size Ø400 mm</li> <li>• 4 white PVC covers</li> </ul> <p>Power supply from ceiling via a flexible sheath Radius of movement of the column in relation to power supply point : 1.5 m Fixing in false ceiling which must not be more than 3 m high Height 2,00 m</p>

Pack	Cat.Nos	Columns and mini-column to be equipped
1	307 03	<p>Comprising:</p> <ul style="list-style-type: none"> <li>• An aluminium base</li> <li>• An adjustable height telescopic pole for installation between the false ceiling and the ceiling (length 1.1 m)</li> <li>• 2 fixing bases with protective covers</li> <li>• 4 white PVC covers</li> </ul> <p><b>4 compartment columns</b></p> <p>Height 2.7 m Can be adapted to a ceiling height 3.8 m Height 3.90 m Can be adapted to a ceiling height of 5 m</p>
1	307 07	

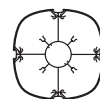

Pack	Cat.Nos	Mini-column
1	307 42	<p><b>Mini-column to be equipped</b></p> <p>Comprising :</p> <ul style="list-style-type: none"> <li>• An aluminium base with 4 compartments</li> <li>• A fixing base with protective cover</li> <li>• 4 aluminium covers</li> <li>• An end cover</li> </ul> <p>Height 68 cm</p>





**Over floor trunking**

---

see p. 749

# wiring accessories for DLP columns and mini-column



# DLP columns and mini-column

## Self-assembly wiring accessory units

To equip your columns, use a wiring accessory support unit. Work out how many sockets you need to install, choose one or more wiring accessory supports and use the table below to calculate the length of unit you need. Allow an additional 20 mm of each end of the unit for fitting the end caps.

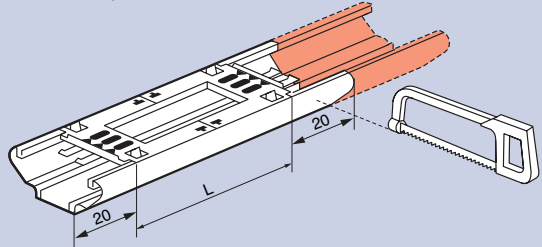

Range	Number of modules or positions	Cat.No of the wiring accessory support	Length L <sup>(1)</sup> of the required unit
60 mm fixing centres wiring accessories	1 gang	1 x 109 13	113 mm
	2 gang	2 x 109 13	243 mm
	3 gang	3 x 109 13	373 mm
	4 gang	4 x 109 13	503 mm
Lexic	3 modules	1 x 109 35	175 mm
	2 modules (1 gang)	1 x 109 22	104 mm
Mosaic	2 x 2 modules	2 x 109 22	224 mm
	3 x 2 modules	3 x 109 22	344 mm
	4 x 2 modules	4 x 109 22	464 mm
	3 modules	1 x 109 32	127 mm
	4 modules (2 gang)	1 x 109 42	149 mm
	2 x 4 modules	2 x 109 42	314 mm
	6 modules (3 gang)	1 x 109 62	194 mm
	2 x 6 modules	2 x 109 62	404 mm
8 modules (4 gang)	1 x 109 82	239 mm	
	2 x 8 modules	2 x 109 82	494 mm

(1) Length excluding dimensions of 2 x 20 mm end caps

Pack	Cat.Nos	Self-assembly wiring accessory units
		For equipping the column with wiring accessories. Equipment to be provided for fitting the wiring accessories: <ul style="list-style-type: none"> <li>• 1 wiring accessory support unit, length 2 m to be cut to length (see opposite)</li> <li>• Wiring accessory support(s)</li> <li>• 2 end caps</li> </ul> <b>Unit</b> 18 <sup>(1)</sup> 307 13  For mounting 60 mm fixing centres wiring accessories, Lexic and Mosaic. Supplied with cable clamp. Length 2 m. 10 307 14  Set of 2 end caps for above unit. <b>Mosaic supports</b> Clip-on supports which can be fitted side by side. For use with screw or automatic connection Mosaic sockets for trunking systems and columns with straight or sloping screw recesses (see p. 562-563). Supplied with finishing plate. 20 109 22  2 modules 5 109 32  3 modules 20 109 42  4 modules 10 109 62  6 modules 10 109 82  8 modules <b>60 mm fixing centres wiring accessories support</b> 10 109 13  1-gang <b>Legrand Lexic support</b> 5 109 35  For 3 modules

(1) Number of meters in pack

## Mounting wiring accessory on modular boxes

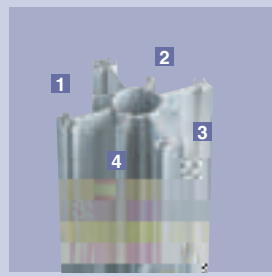

The aluminium unit with separation is suitable for current separation and connection on 4 sides



Install the box



Clip on Mosaic. Add the finishing plate and the end caps

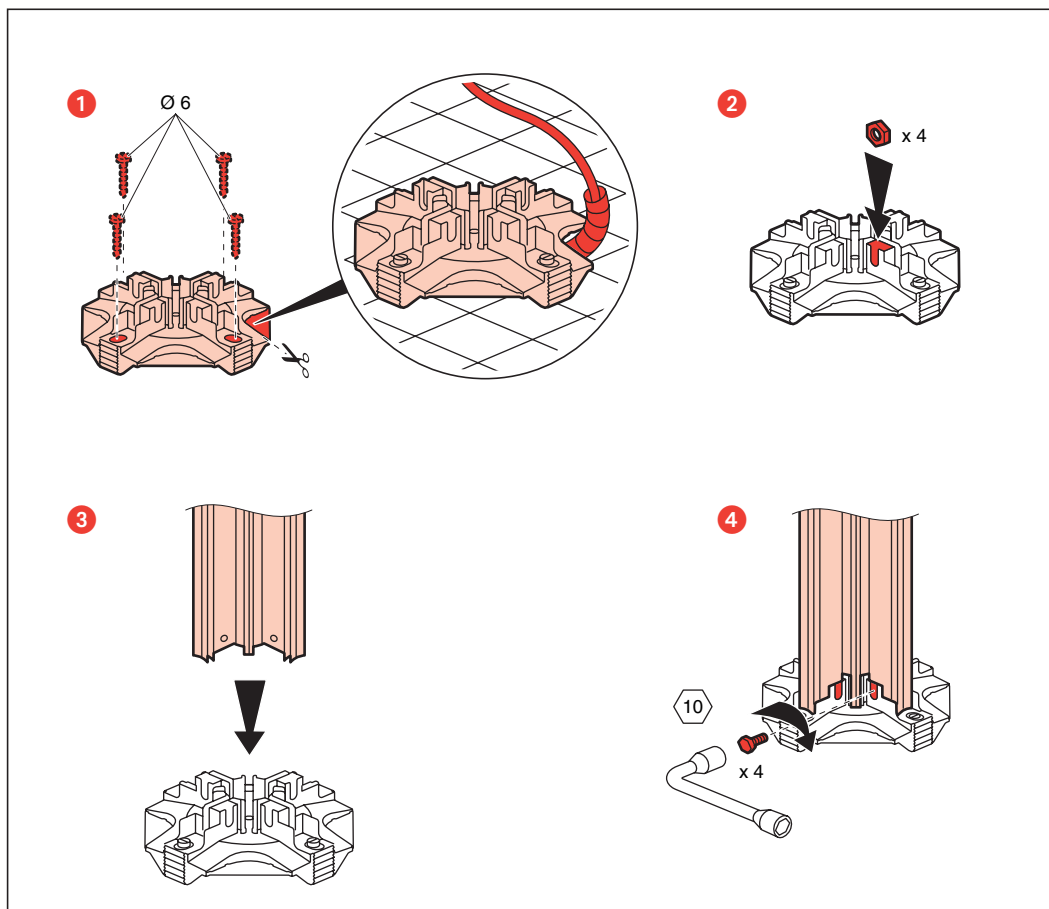
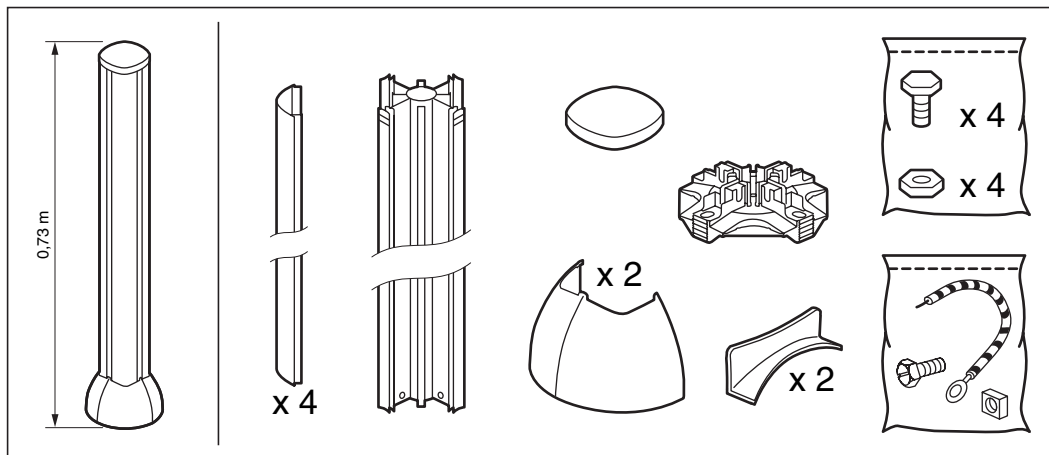

5

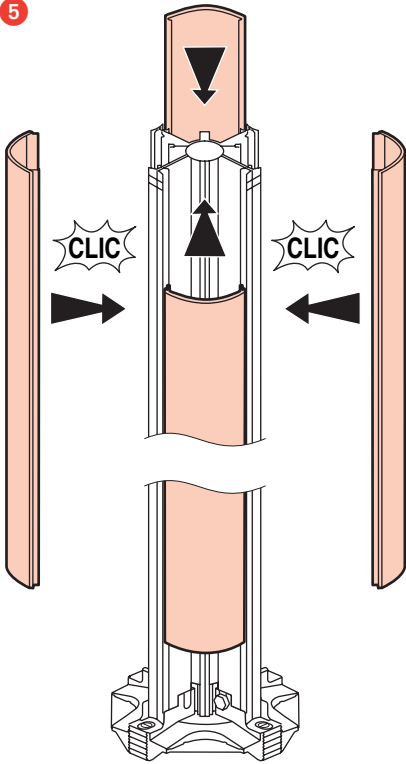

6

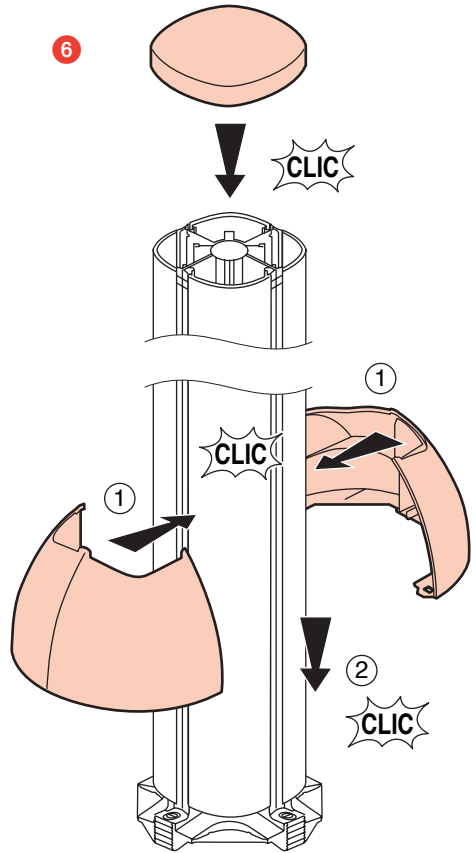

328 00  
6486 00

